

# Super Precision Sealed Angular Contact Ball Bearings

- Packed with grease for easier handling and mounting.
- Standard stock of universal arrangement (single-row) bearings with interchangeable matching.
- Provide customers with the ultimate maintenance free solution for bearings used in machine tool spindles.

**New!**



# Super Precision Sealed Angular Contact Ball Bearings

Immediate cost savings due to factory-filled grease

## Super Precision Sealed Angular Contact Ball Bearings for Machine Tool Main Spindles



### Features of Super Precision Sealed Angular Contact Ball Bearings

- **Time savings**

Prepacked bearing eliminates the need to pack grease into the bearing when the main spindle is assembled, thus avoiding any chance of contamination or incorrect grease packing.

- **Flexibility for arrangement**

Standard stock of interchangeable universal arrangement (SU) bearings.

- **Improved cleanliness**

Grease leakage is reduced thus keeping working environment clean and safe with no impact on the environment.

- **Exclusive seal design**

High-speed operations achieved with a non-contact seal. Nitrile rubber ensures superior oil resistance, wear resistance, and enhanced mechanical properties. TAC series uses contact seals, which provide superior water resistance and dust resistance.

- **Optimum cage design**

#### Features of outer ring guided phenolic resin cages

Types T and TR offer high-speed capability. Outer ring guided phenolic resin cage offers superior stability at high-speed.

#### Features of ball guided polyamide resin cage

NSK's original design  
Type TYN (applied for bearing types BNR10 and BER10)

- **Reduced cage noise**
- **Reduced bearing wear at low speeds**
- **Enhanced grease life**

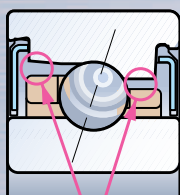

Space for grease

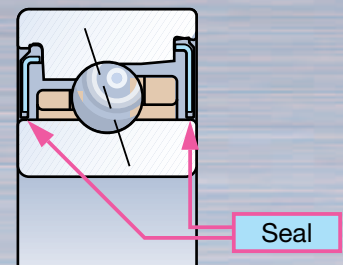

Limiting speeds

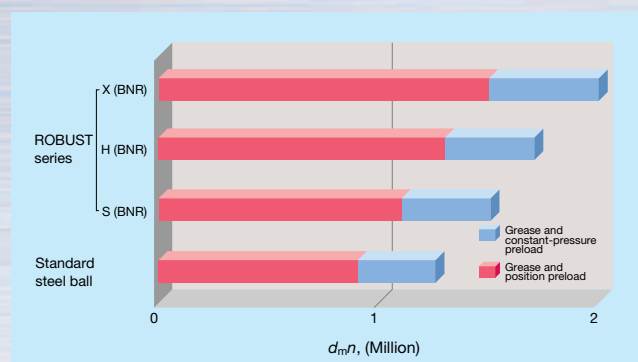

# List of Super Precision Sealed Angular Contact Ball Bearing Series

## Ultra high-speed Robust series

Example of bearing number: 60BNR10XTV1VSUELP3 MTSX

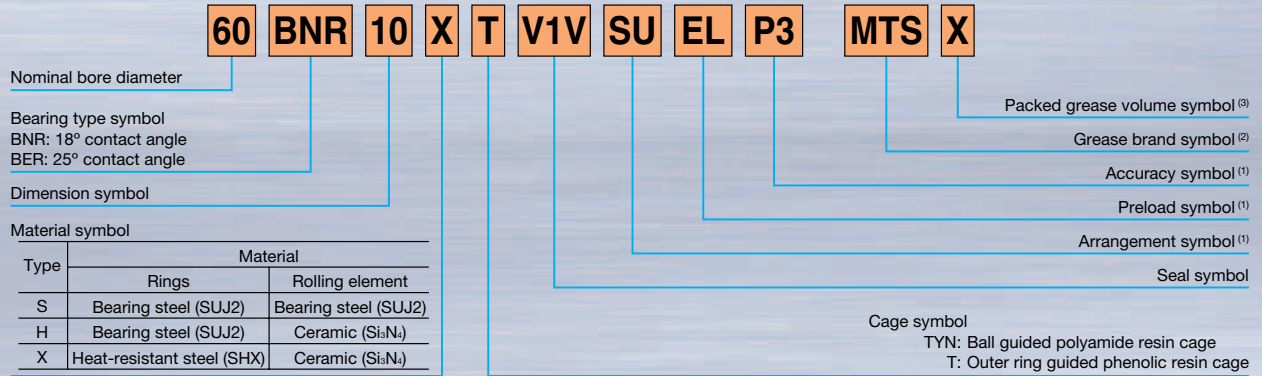

## Standard series

Example of bearing number: 7010CTRV1VSULP3 MTSX

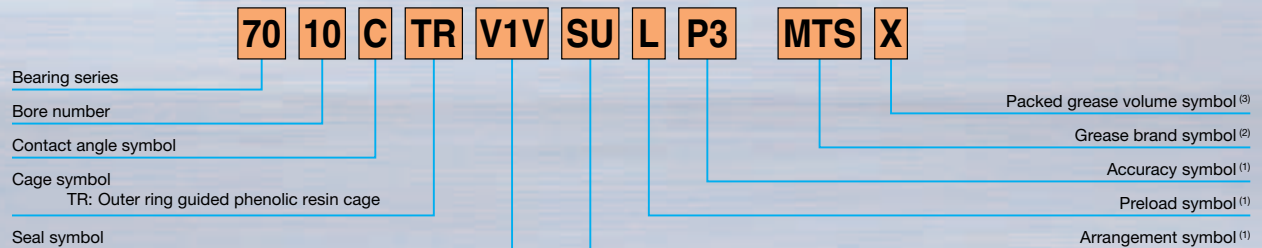

## TAC series for ball screw support

Example of bearing number: 30TAC62BDDGSUC10PN7B WPHL

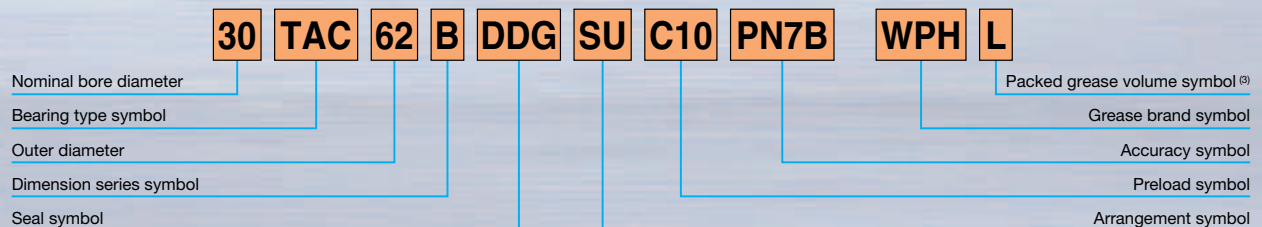

WPH grease is used as a standard.

### Bearings available with seal

Dimension series	Bearing bore
BNR10, BNR19, 70, 79 BER10, BER19	φ30~φ100 <sup>(4)</sup>

Notes <sup>(1)</sup> Additional arrangements, preloads and accuracy classes are available. Consult with your NSK sales office.

<sup>(2)</sup> MTS and MTE are the standard grease products for ultra high-speed Robust series and Standard series bearings.

<sup>(3)</sup> Open bearings: X=15% L=30%  
Sealed bearings: X=20% L=40%

<sup>(4)</sup> For more information on other sizes, consult your NSK Sales Engineer.

### Cross section view of bearings

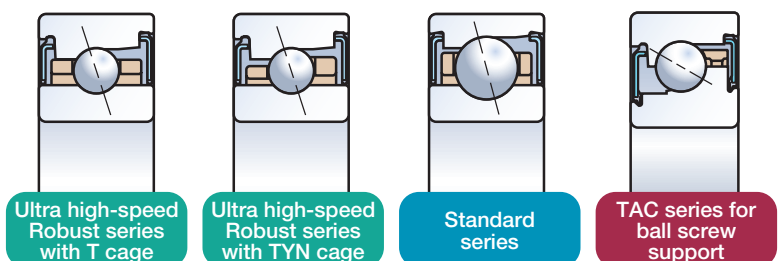

# SU arrangement: universal arrangement (single-row) bearings with interchangeable matching

## Features of SU arrangement

Preload offset has been specifically controlled on both bearing faces ( $f=b$ ).

Designated preload can be set for any combination of bearings.

A “V” mark is used on the outer diameter to identify the proper orientation of assembly and thereby avoiding assembly errors. The “V” is marked as shown. Arrange “V” marks to make the shape shown in the following examples for your desired arrangement.

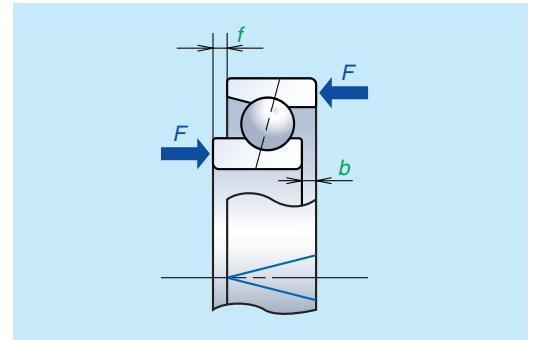

## Example of matching of angular contact ball bearings

Offset of outer and inner ring face arrangements allow for a variety of matching combinations.

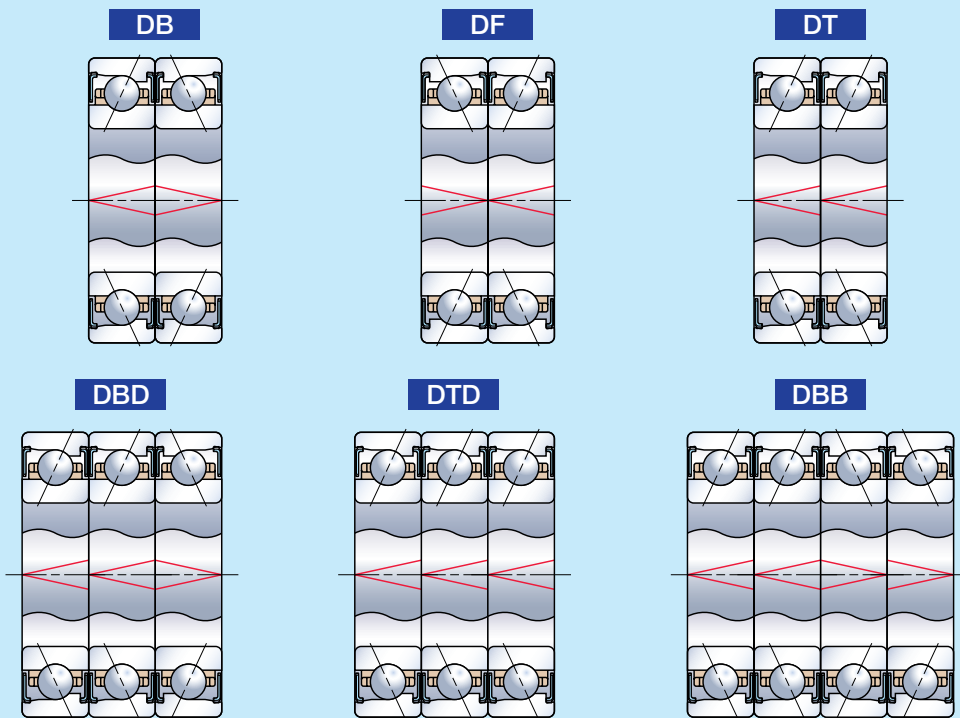

## Sealed spacer

### Features of sealed spacer

- This seal reduces the leakage of grease.
- In grease lubrication, this spacer provides superior resistance against intrusion of foreign particles and coolant, thus ensuring greater reliability.



# NSK High-Speed and High-Performance Grease MTS, MTE, ENS

MTS, MTE, and ENS are specially developed grease products sold exclusively by NSK. Our super precision sealed angular contact ball bearings come prepacked with MTS and MTE grease.



## Applications and features of grease

### ● Heat-resistant MTS grease

Applications: Ultra high-speed machining centers

Features: Urea thickener provides superior heat resistance.

### ● High-load MTE grease

Applications: Lathe operated under high loads

Features: Superior load resistance

### ● High-temperature resistant ENS grease

Applications: High-speed motors

Features: Environmentally friendly biodegradable grease

## Grease properties

Items	Test condition	MTS	MTE	ENS	Test method
Thickener	—	Urea	Barium complex	Urea	—
Base oil	—	Ester oil Synthetic hydrocarbon oil	Ester oil	Ester oil	—
Kinematic viscosity of base oil (mm <sup>2</sup> /s)	40	22	20	32	JIS K2220 5.19
Consistency	25°C, 60W	No. 2 to 3	No. 2	No. 2	JIS K2220 5.3
Dropping point (°C)	—	> 220	> 200	> 260	JIS K2220 5.4
Evaporation (mass%)	99°C×22H	0.3	0.4	0.4	JIS K2220 5.6B
Oil separation (mass%)	100°C×24H	0.4	1.0	1.1	JIS K2220 5.7

## Sales of grease volumes

Volume	Container	MTS	MTE	ENS
100g	Tube	□	□	—
1kg	Can	□	□	—
2.5kg	Can	—	—	□