

NSK Linear Guides

Miniature PU Series/PE Series



Patent Pending

Ideal for semiconductor manufacturing and medical equipment; series now includes linear guides with high-load capacity

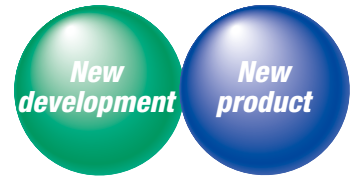

Smooth motion and unprecedented lightness

The advanced NSK Miniature Linear Guides

The new generation PU series/PE series inherit the outstanding lineage of the NSK miniature linear guides LU series/LE series. Resin ball recirculation components improve dynamic friction characteristics and create smoother motion with reduced noise intensity. High performance features enhanced dust resistance, low dust generation, and high corrosion resistance. The new design supports a wide variety of applications.

1 Features

1. Motion performance

Newly designed recirculation component facilitates smooth circulation of steel balls.

2. Lightweight

The ball slide is fabricated to be approximately 20% lighter than conventional models* by the application of resin to a part of its body.

* Miniature LU series/LE series

3. Reduced noise intensity

Resin components applied in the ball circulating system reduce collision noise between steel balls and the inner wall of circulating circuits.

4. Low dust generation

The new design generates less dust compared to conventional models.

5. Excellent dust resistance

Compact space between the side of the rails and the inner walls of the ball slide prevents the entrance of foreign matter.

6. High corrosion resistance

High corrosion-resistant martensite stainless steel is incorporated as a standard feature provides excellent resistance to corrosion.

7. Easy to handle

Safety design includes a retainer that prevents steel balls from dropping out of the ball slide even when the slide is removed from the rail.

8. Long-term maintenance-free

Equipped with NSK K1™ Lubrication unit realizes long-term, maintenance-free use.

9. Fast delivery

Lineup of interchangeable rails and ball slides in the series supports random matching and facilitates fast delivery.

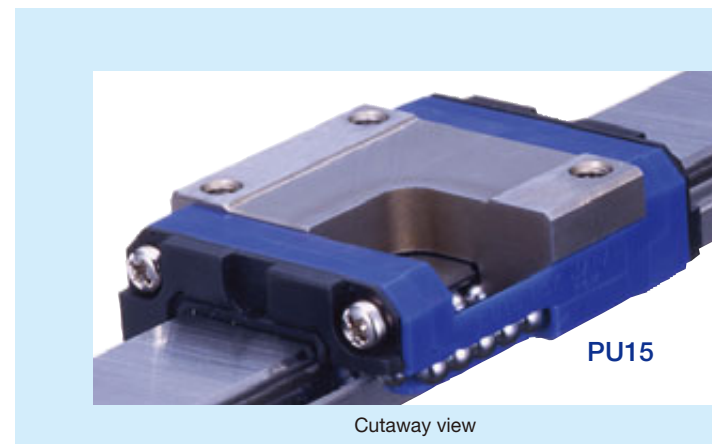
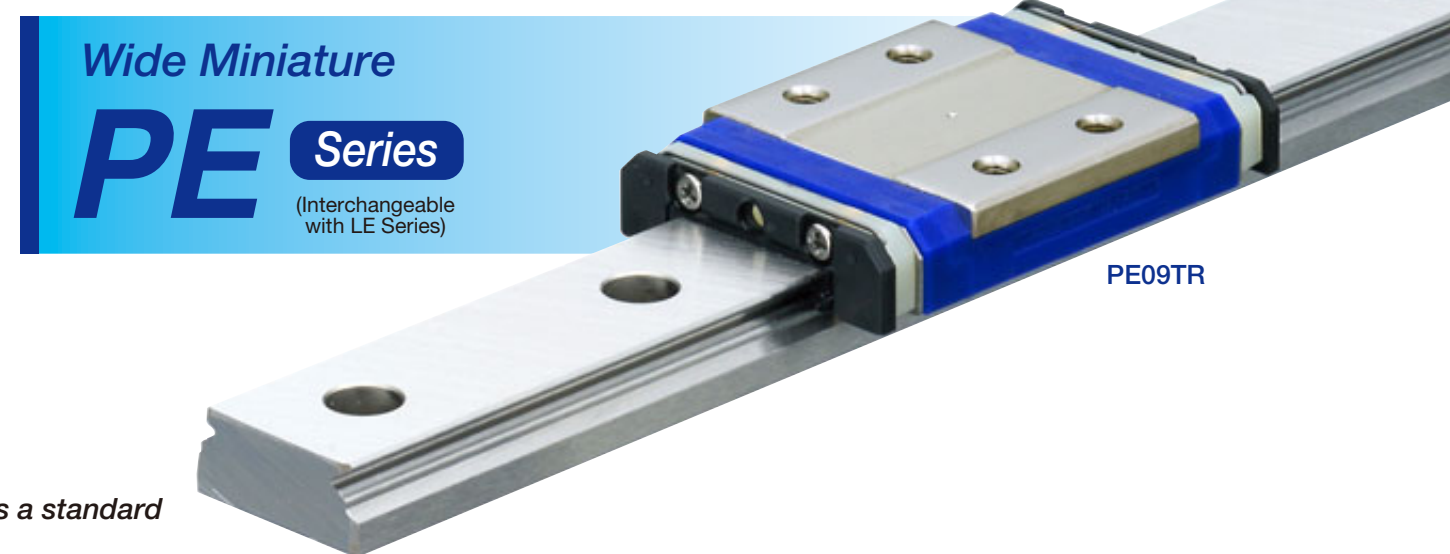

Smoother motion

The resin ball recirculation component creates an optimal configuration allowing gentler contact with circulating steel balls, resulting in improved dynamic friction characteristics and smoother motion.

Test conditions: Oil lubrication (VG68)
Operating speed: 1,000 mm/min
Load cell rated capacity: 5N

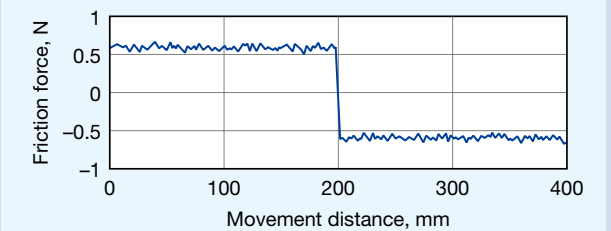

Fig. 1-1 Fluctuations in dynamic friction

Low dust generation

The PU series/PE series, with resin ball recirculation components, generates less dust than a conventional ball recirculation hole that goes right through the ball slide.

Test conditions: Grease lubrication (LG2)
Operating speed: 600 mm/min
Stroke: 200 mm

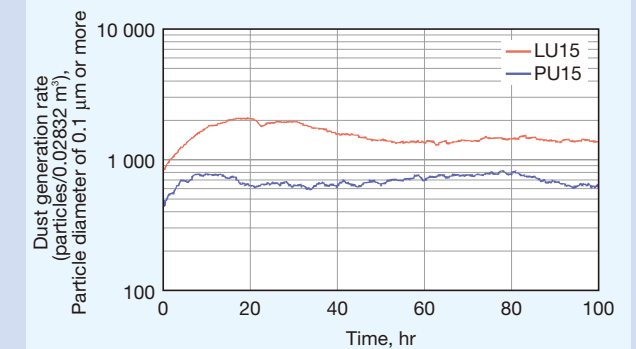

Fig. 1-2 Dust generation rate

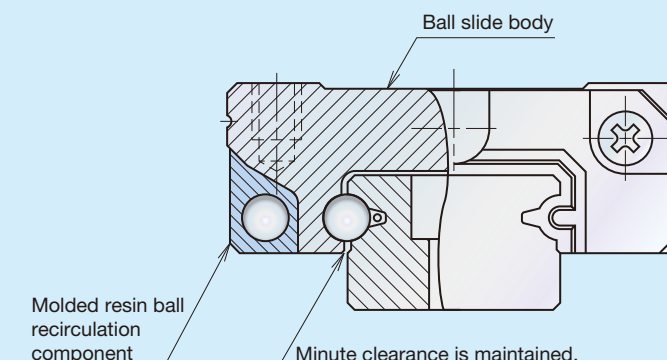

Fig. 2 Cross sectional front view

Developed for precision positioning tables, supporting cutting-edge equipment, including semiconductor manufacturing and medical devices—NSK Linear Guides Miniature PU Series/PE Series

2 Reference number

Reference numbers will be used as reference before finalizing all specifications. These numbers indicate outline specifications. Please specify the reference number, except design serial number, to identify the product when ordering, requesting estimates, or inquiring about specifications from NSK. The reference number is a set number for a single rail. For multiple rails, at least two sets of reference numbers are required.

2.1 Preloaded assembly type

Example: **PU 15 0470 AL K 2 -** P5 1 - II**

Series name: PU, Size: 15, Rail length (mm): 0470, Ball slide shape code: AL, Material/surface treatment: K, Number of ball slides per rail: 2, Accuracy grade: P5, Preload code: 1, No end code: -II

Accuracy grade PN: Normal, P6: Precision, P5: High precision, P4: Super precision (with NSK K1) KN: Normal, K6: Precision, K5: High precision, K4: Super precision

Preload code 0: Fine clearance (Z0), 1: Slight preload (Z1)

Design serial number: -II

Material/surface treatment K: Stainless steel, H: Stainless steel + surface treatment

(*) Please note that the appropriate design number will be inserted into the reference number and the tag end code (-II) will be omitted.

2.2 Interchangeable type

(1) Reference number for rail and ball slide assembly

Example: **PU 15 0470 AL K 2 -** PC T - II**

Series name: PU, Size: 15, Rail length (mm): 0470, Ball slide shape code: AL, Material/surface treatment: K, Number of ball slides per rail: 2, Accuracy grade: PC, Preload code: T, No end code: -II

Accuracy grade PC: Normal (with NSK K1) KC: Normal

Preload code T: Fine clearance compatible (ZT)

Design serial number: -II

Material/surface treatment K: Stainless steel, H: Stainless steel + surface treatment

(*) Please note that the appropriate design number will be inserted into the reference number and the tag end code (-II) will be omitted.

(2) Reference number for ball slide of interchangeable type

Example: **PA U 15 AL S - K**

Single ball slide code: PA, Series name: U, Size: 15, Ball slide shape code: AL, Material code: S, Option code: -K

Series name U: PU, E: PE

Material code S: Stainless steel

Ball slide shape code

(3) Reference number for rail of interchangeable type

Example: **P1 U 15 0470 R K N -** PC T**

Single rail code: P1, Series name: U, Size: 15, Rail length (mm): 0470, Rail shape code: R, Material/surface treatment: K, Accuracy grade: N, Butting specification code: -, Preload code: **, Accuracy grade: PC, Preload code: T

Series name U: PU, E: PE

Accuracy grade PC: Normal

Design serial number: -II

Butting specification code (*) N: non-butting rails, L: Butting specification

Material/surface treatment K: Stainless steel, H: Stainless steel + surface treatment

(*) Please contact NSK for more details about the rail butting specification.

3 Accuracy standard

We offer the following product accuracy grades: Super precision grade P4, High precision grade P5, Precision grade P6, and Normal grade PN for preloaded assembly type, and Normal grade PC for interchangeable type.

Table 1 Accuracy standard for preloaded assembly types Unit: μm

Item	Accuracy grade			
	Super precision P4	High precision P5	Precision P6	Normal PN
Mounting height H	± 10	± 15	± 20	± 40
Variation of Mounting height H (All ball slides on a pair of rails)	5	7	15	25
Mounting width dimension W_2 or W_3	± 15	± 20	± 30	± 50
Variation of Mounting width dimension W_2 or W_3 (All ball slides on datum rails)	7	10	20	30
Running parallelism of face C against face A	Refer to Table 3, Fig. 3, Fig. 4			
Running parallelism of face D against face B				

Table 3 Running parallelism tolerance Unit: μm

Rail length (mm)	Accuracy grade				Interchangeable type	
	Preloaded assembly type	Preloaded assembly type		Interchangeable type		
over or less	P4	P5	P6	PN	PC	
50 – 80	2	2	4.5	6	6	
80 – 125	2	3	5	6	6	
125 – 200	2	3.5	5.5	6.5	6.5	
200 – 250	2.5	5	7	8	8	
250 – 315	2.5	5	8	9	9	
315 – 400	3	6	9	11	11	
400 – 500	3	6	10	12	12	
500 – 630	3.5	7	12	14	14	
630 – 800	4.5	8	14	16	16	
800 – 1000	5	9	16	18	18	
1000 – 1250	6	10	17	20	20	

Table 2 Accuracy standard for interchangeable type Unit: μm

Item	Accuracy grade
	Normal PC
Mounting height H	± 20
Variation of Mounting height H (one rail)	15
Variation of Mounting height H (multiple rails)	30
Mounting width dimension W_2 or W_3	± 20
Variation of Mounting width dimension W_2 or W_3 (All ball slides on datum rails)	20
Running parallelism of face C against face A	Refer to Table 3, Fig. 3, Fig. 4
Running parallelism of face D against face B	

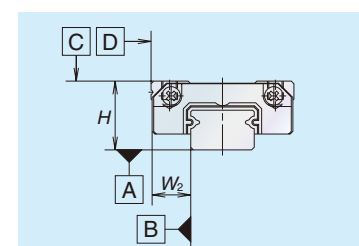

Fig. 3 Drawing for accuracy standard (Mounting width W_2)

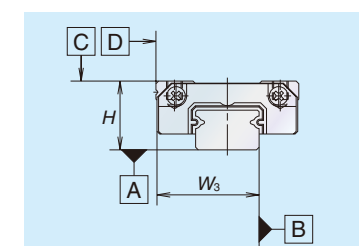

Fig. 4 Drawing for accuracy standard (Mounting width W_3)

4 Preload and rigidity

We offer three levels of preload: Slight preload (Z1) and Fine clearance (Z0) for preloaded assembly types, along with interchangeable types of Fine clearance (ZT). Values for preload and rigidity of the preloaded assembly types are shown in Tables 4 and 5.

Table 4 Preload and rigidity of preloaded assembly of PU series

	Model No.	Preload (N)		Rigidity (N/μm)	
		Slight preload (Z1)	Slight preload (Z1)	Slight preload (Z1)	Slight preload (Z1)
Standard type	PU05TR	0 - 3		17	
	PU07AR	0 - 8		22	
	PU09TR	0 - 10		30	
	PU12TR	0 - 17		33	
	PU15AL	0 - 33		45	
High-load capacity type	PU09UR	0 - 14		46	
	PU12UR	0 - 25		52	
	PU15BL	0 - 51		75	

Table 5 Preload and rigidity of preloaded assembly of PE series

	Model No.	Preload (N)		Rigidity (N/μm)	
		Slight preload (Z1)	Slight preload (Z1)	Slight preload (Z1)	Slight preload (Z1)
Standard type	PE05AR	0 - 28		45	
	PE07TR	0 - 29		46	
	PE09TR	0 - 37		61	
	PE12AR	0 - 40		63	
	PE15AR	0 - 49		66	
High-load capacity type	PE09UR	0 - 54		86	
	PE12BR	0 - 59		97	
	PE15BR	0 - 75		114	

Clearance of fine clearance Z0 is 0-3 μm. Therefore, preload is zero.

Clearance values of the interchangeable types are shown in Tables 6 and 7.

Table 6 Clearance of interchangeable type of PU series Unit: μm

	Model No.	Fine clearance ZT
Standard type	PU05TR	Less than 3
	PU07AR	
	PU09TR	
	PU12TR	
	PU15AL	

Only standard models are available for interchangeable type.

Table 7 Clearance of interchangeable type of PE series Unit: μm

	Model No.	Fine clearance ZT
Standard type	PE05AR	Less than 3
	PE07TR	
	PE09TR	
	PE12AR	
	PE15AR	

Only standard models are available for interchangeable type.

5 Applications

- **Smoother motion and low dust generation**
Liquid crystal manufacturing and printed circuit board manufacturing devices
- **Lightweight and low dust generation**
Semiconductor manufacturing devices (mounter, die bonder, and exposure device)
- **Gentler tone and excellent dust resistant features**
Medical machinery and various precision devices

6 Height and corner configuration of the mount face

Figs. 5, 6 and Tables 8, 9 show the shoulder height and corner radius dimensions. These dimensions should be referred to when fixing the linear guide horizontally by pushing it onto the shoulder (projected portion from the mount face) of the bed or table.

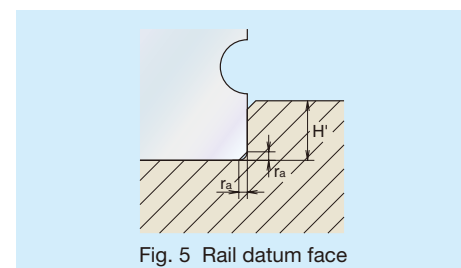

Fig. 5 Rail datum face

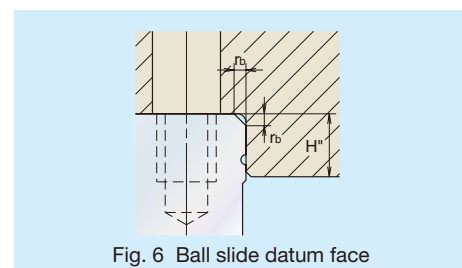

Fig. 6 Ball slide datum face

Table 8 Shoulder height and corner radius of the mount face (PU series) Unit: mm

Model No.	Corner radius (Maximum)		Shoulder height	
	r _a	r _b	H'	H''(*)
PU05	0.2	0.2	0.7	2.3
PU07	0.2	0.3	1.2	2.5
PU09	0.3	0.3	1.9	2.6
PU12	0.3	0.3	2.5	3.4
PU15	0.3	0.5	3.5	4.4

(*)H'' is the minimum recommended value based on the dimension T in Table 13.

Table 9 Shoulder height and corner radius of the mount face (PE series) Unit: mm

Model No.	Corner radius (Maximum)		Shoulder height	
	r _a	r _b	H'	H''(*)
PE05	0.2	0.2	1.1	2.5
PE07	0.2	0.3	1.7	3
PE09	0.3	0.3	3.5	2.8
PE12	0.3	0.3	3.5	3.2
PE15	0.3	0.5	3.5	4.1

(*)H'' is the minimum recommended value based on the dimension T in Table 14.

7 Lubrication

Selection of grease: Table 10 below shows grease that is suitable for the PU series/PE series. We specify PS2 as the standard grease for NSK miniature linear guides.

Table 10 Grease list

Grease code	Thickener	Base oil	Base oil kinematic viscosity mm ² /s (40°C)	Temperature range for use (°C)	Characteristic/Application
PS2	Lithium type	Synthetic oil + Mineral oil	15	-50 to 110	<ul style="list-style-type: none"> • Better low temperature and dynamic characteristics • Suitable for high speed and light load application
LG2	Lithium type	Mineral oil + Synthetic hydrocarbon oil	30	-10 to 80	<ul style="list-style-type: none"> • Low dust emission grease for clean room application
LGU	Diurea type	Synthetic hydrocarbon oil	100	-30 to 120	<ul style="list-style-type: none"> • Low dust emission grease for high temperature, clean room application

8 Dust resistance

Side seal: Provided to both sides of the ball slide as a standard feature.

Bottom seal function: A labyrinth structure of the ball slide bottom face functions as sealing effect.

NSK K1™: Lubrication unit. Tables 11 and 12 shows the related dimensions when attaching NSK K1™.

Table 11 Dimensions when attaching NSK K1 (PU series) Unit: mm

	Model No.	Ball slide length when attaching two NSK K1s, L	Thickness of single NSK K1, V ₁	Thickness of protection cover, V ₂
Standard type	PU05TR	24.4	2	0.5
	PU07AR	29.4	2.5	0.5
	PU09TR	36.4	2.7	0.5
	PU12TR	42	3	0.5
	PU15AL	51.2	3.5	0.6
High-load capacity type	PU09UR	47.4	2.7	0.5
	PU12UR	55.7	3	0.5
	PU15BL	69.2	3.5	0.6

Ball slide length when attaching NSK K1 = ("Standard ball slide length") + ("Thickness of single NSK K1, V₁ × Numbers of NSK K1s) + ("Thickness of protection cover", V₂ × 2)

Table 12 Dimensions when attaching NSK K1 (PE series) Unit: mm

	Model No.	Ball slide length when attaching two NSK K1s, L	Thickness of single NSK K1, V ₁	Thickness of protection cover, V ₂
Standard type	PE05AR	28.9	2	0.4
	PE07TR	37.1	2.5	0.5
	PE09TR	46.8	3	0.5
	PE12AR	53	3.5	0.5
	PE15AR	66.2	4	0.8
High-load capacity type	PE09UR	58.2	3	0.5
	PE12BR	68	3.5	0.5
	PE15BR	85.6	4	0.8

Ball slide length when attaching NSK K1 = ("Standard ball slide length") + ("Thickness of single NSK K1, V₁ × Numbers of NSK K1s) + ("Thickness of protection cover", V₂ × 2)

9 Dimensions

9.1 Rail and ball slide assembly (preloaded type, interchangeable type) Only standard models are available for interchangeable type.

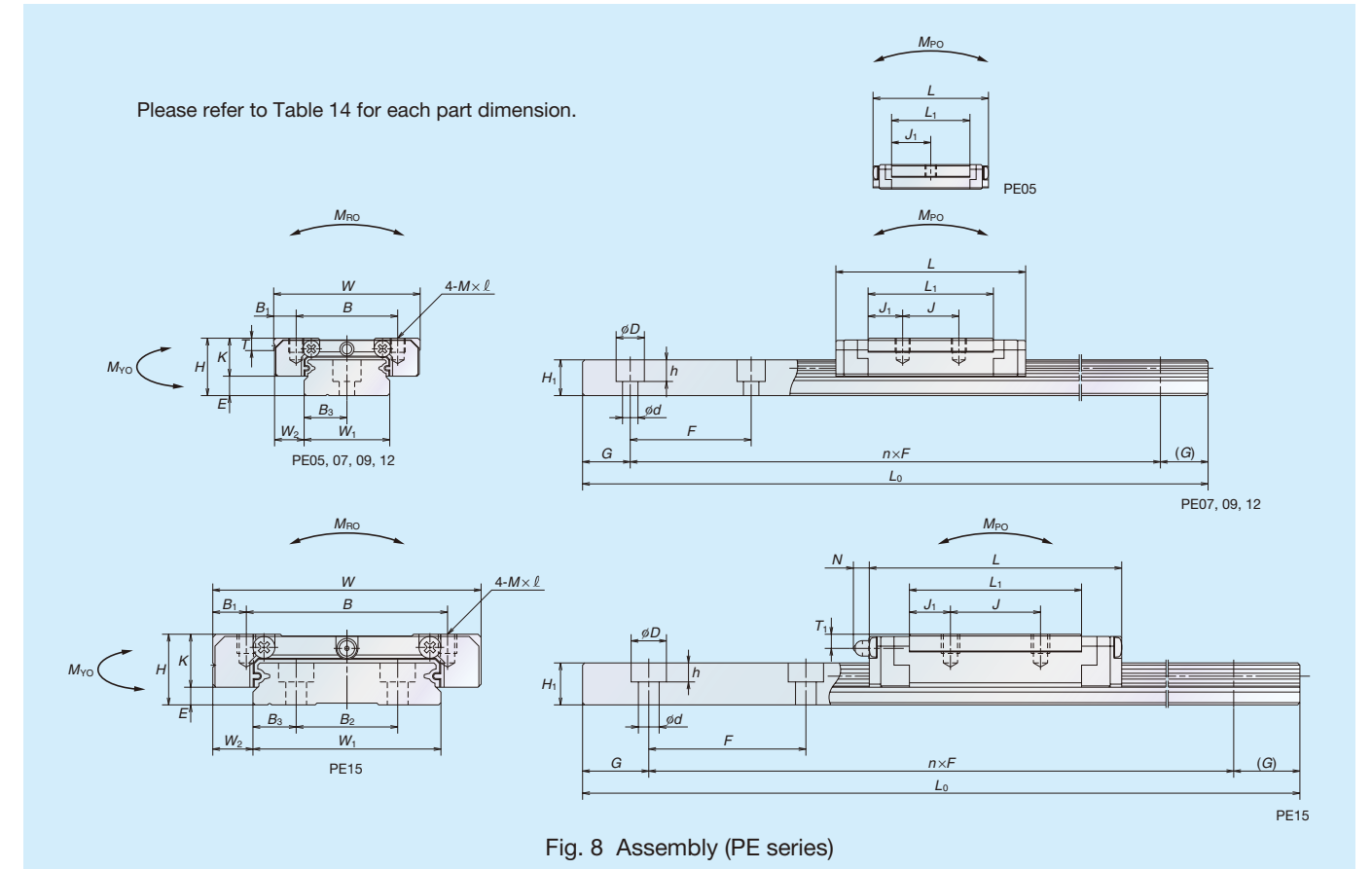
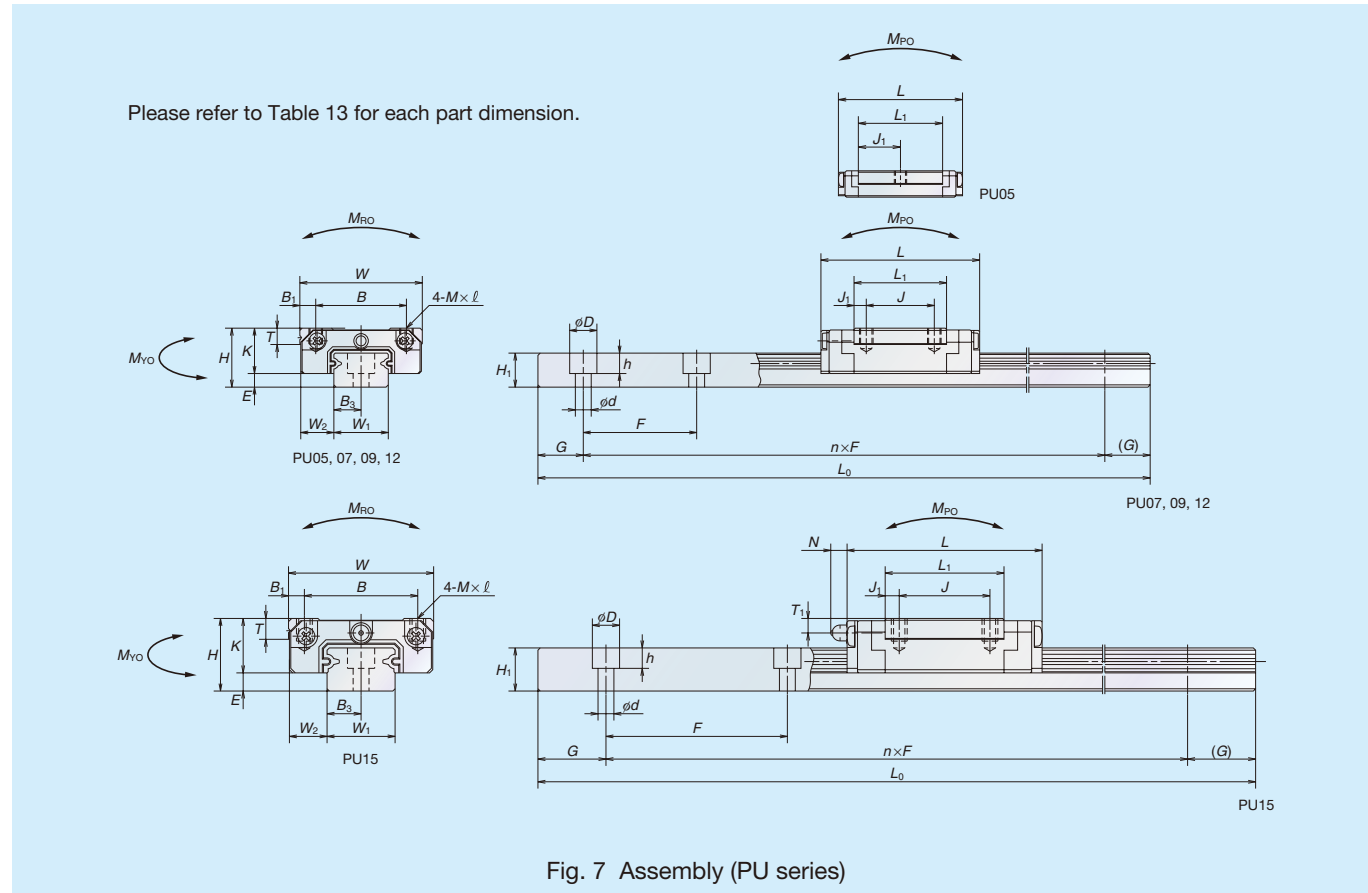

Fig. 7 Assembly (PU series)

Fig. 8 Assembly (PE series)

Table 13 Dimensions (PU series)

Model No.	Interchangeable type	Assembly		Ball slide														Rail							Basic load rating (*2)					Ball diameter	Weight			
		Height	E	W ₂	Width	Length	Mounting hole					B ₁	L ₁	J ₁	K	T	Grease fitting			Width	Height	Pitch	Mounting bolt hole	B ₃	G (recommended)	Maximum length L _{0max}	Dynamic C (N)	Static C ₀ (N)	Static moment (N-m)			D _W	Ball slide (g)	Rail (g/100 mm)
							B	J	M×Pitch×ℓ	Port diameter	T ₁						N	M _{R0}	M _{P0}										M _{Y0}					
Standard type	PU05TR	○	6	1	3.5	12	19.4	8	—	M2×0.4×1.5	2	11.4	5.7	5	2.3	∅1	(1.5)	—	5	3.2	15	2.3×3.3×0.8	2.5	5	210	520	775	2.1	1.3	1.3	1	4	11	
	PU07AR	○	8	1.5	5	17	23.4	12	8	M2×0.4×2.4	2.5	13.3	2.65	6.5	2.45	∅1.5	(1.8)	—	7	4.7	15	2.4×4.2×2.3	3.5	5	375	1 090	1 370	5.2	2.7	2.7	1.5875	8	23	
	PU09TR	○	10	2.2	5.5	20	30	15	10	M3×0.5×3	2.5	19.6	4.8	7.8	2.6	∅2	(2.3)	—	9	5.5	20	3.5×6×4.5	4.5	7.5	600	1 490	2 150	10	6.1	6.1	1.5875	16	35	
	PU12TR	○	13	3	7.5	27	35	20	15	M3×0.5×3.5	3.5	20.4	2.7	10	3.4	∅2.5	(2.8)	—	12	7.5	25	3.5×6×4.5	6	10	800	2 830	3 500	21.7	11.4	11.4	2.3812	32	65	
	PU15AL	○	16	4	8.5	32	43	25	20	M3×0.5×5	3.5	26.2	3.1	12	4.4	∅3 (*1)	(3.2)	(3.3)	15	9.5	40	3.5×6×4.5	7.5	15	1 000	5 550	6 600	49.5	25.6	25.6	3.175	59	105	
High-load capacity type	PU09UR		10	2.2	5.5	20	41	15	16	M3×0.5×3	2.5	30.6	7.3	7.8	2.6	∅2	(2.3)	—	9	5.5	20	3.5×6×4.5	4.5	7.5	600	2 100	3 500	16.4	15.6	15.6	1.5875	25	35	
	PU12UR		13	3	7.5	27	48.7	20	20	M3×0.5×3.5	3.5	34.1	7.05	10	3.4	∅2.5	(2.8)	—	12	7.5	25	3.5×6×4.5	6	10	800	4 000	5 700	35	28.3	28.3	2.3812	53	65	
	PU15BL		16	4	8.5	32	61	25	25	M3×0.5×5	3.5	44.2	9.6	12	4.4	∅3 (*1)	(3.2)	(3.3)	15	9.5	40	3.5×6×4.5	7.5	15	1 000	8 100	11 300	54.5	69.5	69.5	3.175	100	105	

○: Interchangeable type is available.

(*1) Drive-In grease nipple for ∅3 is attached to PU15.
(*2) The basic load ratings comply with ISO standards.

To fix rails of PU05TR, use M2 × 0.4 cross-recessed pan head machine screw for precision instrument.
(JCIS 10-70 No. 0 pan head machine screw No. 1)
(JCIS: Japanese Camera Industrial Standard)

Table 14 Dimensions (PE series)

Model No.	Interchangeable type	Assembly		Ball slide														Rail							Basic load rating (*2)					Ball diameter	Weight			
		Height	E	W ₂	Width	Length	Mounting hole					B ₁	L ₁	J ₁	K	T	Grease fitting			Width	Height	Pitch	Mounting bolt hole	B ₃	G (recommended)	Maximum length L _{0max}	Dynamic C (N)	Static C ₀ (N)	Static moment (N-m)			D _W	Ball slide (g)	Rail (g/100 mm)
							B	J	M×Pitch×ℓ	Port diameter	T ₁						N	M _{R0}	M _{P0}										M _{Y0}					
Standard type	PE05AR	○	6.5	1.4	3.5	17	24.1	13	—	M2.5×0.45×1.5	2	16.4	8.2	5.1	2.5	∅1	(1.3)	—	10	4	—	20	3×5×1.6	5	7.5	150	690	1 160	6	2.8	2.8	1	7	34
	PE07TR	○	9	2	5.5	25	31.1	19	10	M3×0.5×2.8	3	20.8	5.4	7	3	∅1.9	(1.9)	—	14	5.2	—	30	3.5×6×3.2	7	10	600	1 580	2 350	16.7	7.2	7.2	1.5875	19	55
	PE09TR	○	12	4	6	30	39.8	21	12	M3×0.5×3	4.5	26.6	7.3	8	2.8	∅2	(2.3)	—	18	7.5	—	30	3.5×6×4.5	9	10	800	3 000	4 500	36.5	17.3	17.3	2	35	95
	PE12AR	○	14	4	8	40	45	28	15	M3×0.5×4	6	31	8	10	3.2	∅2.5	(2.7)	—	24	8.5	—	40	4.5×8×4.5	12	15	1 000	4 350	6 350	70.5	29.3	29.3	2.3812	66	140
	PE15AR	○	16	4	9	60	56.6	45	20	M4×0.7×4.5	7.5	38.4	9.2	12	4.1	∅3 (*1)	(3.2)	(3.3)	42	9.5	23	40	4.5×8×4.5	9.5	15	1 200	7 600	10 400	207	59	59	3.175	140	275
High-load capacity type	PE09UR		12	4	6	30	51.2	23	24	M3×0.5×3	3.5	38	7	8	2.8	∅2	(2.3)	—	18	7.5	—	30	3.5×6×4.5	9	10	800	4 000	6 700	54.5	37.5	37.5	2	50	95
	PE12BR		14	4	8	40	60	28	28	M3×0.5×4	6	46	9	10	3.2	∅2.5	(2.7)	—	24	8.5	—	40	4.5×8×4.5	12	15	1 000	5 800	9 550	106	63.5	63.5	2.3812	98	140
	PE15BR		16	4	9	60	76	45	35	M4×0.7×4.5	7.5	57.8	11.4	12	4.1	∅3 (*1)	(3.2)	(3.3)	42	9.5	23	40	4.5×8×4.5	9.5	15	1 200	10 300	16 000	320	135	135	3.175	211	275

○: Interchangeable type is available.

(*1) Drive-In grease nipple for ∅3 is attached to PE15.
(*2) The basic load ratings comply with ISO standards.

To fix PE05AR, use M2.5 × 0.45 cross-recessed pan head machine screw for precision instrument.
(JCIS 10-70 No. 0 pan head machine screw No. 1)
(JCIS: Japanese Camera Industrial Standard)

9.2 Interchangeable type

(1) Ball slide of interchangeable types

Only standard models are available for interchangeable type.

Please refer to Table 13 for each part dimension.

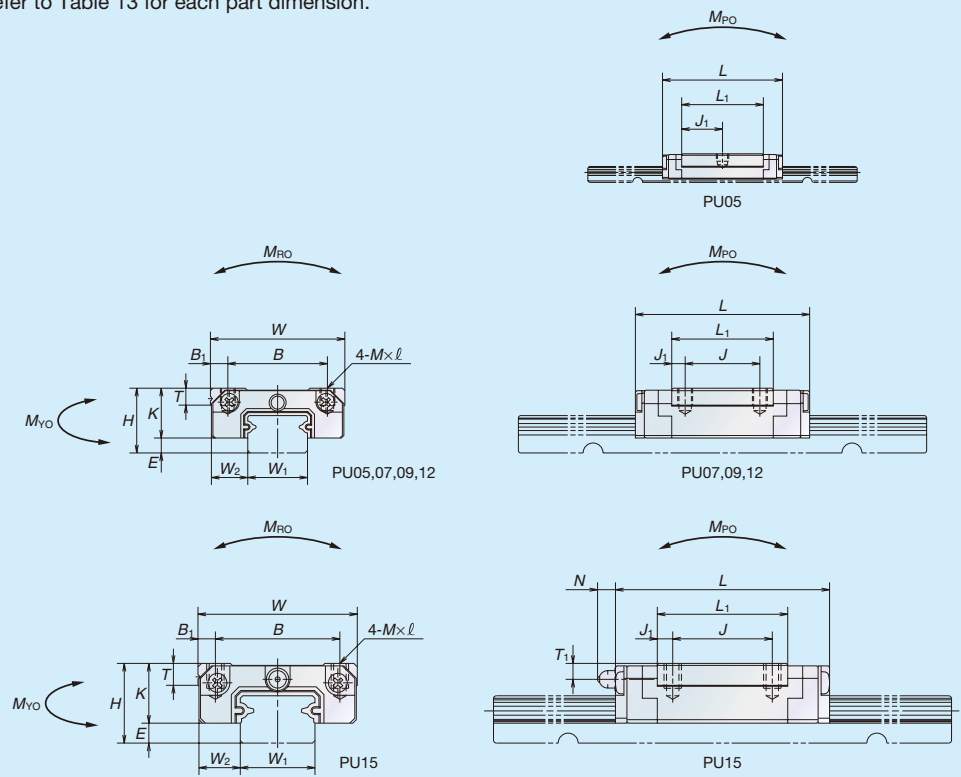

Fig. 9 Ball slide of interchangeable types (PU series)

Please refer to Table 14 for each part dimension.

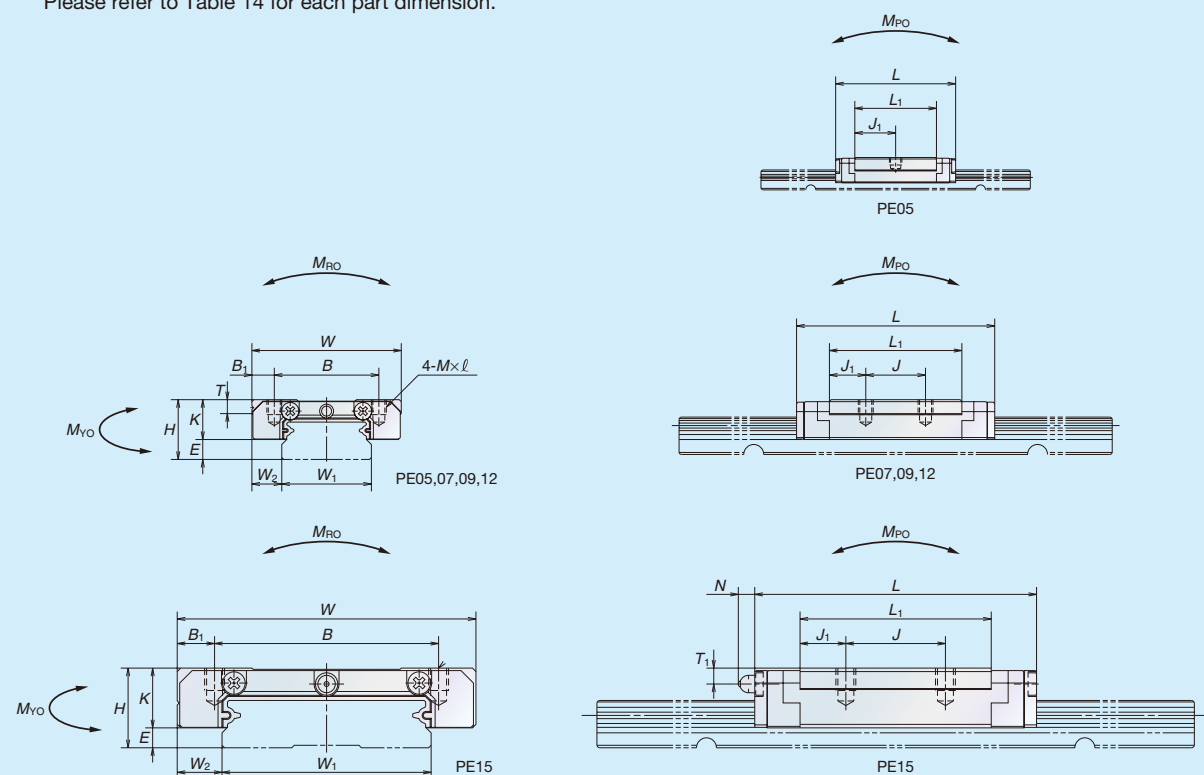

Fig. 10 Ball slide of interchangeable types (PE series)

(2) Rail of interchangeable types

Please refer to Table 13 for each part dimension.

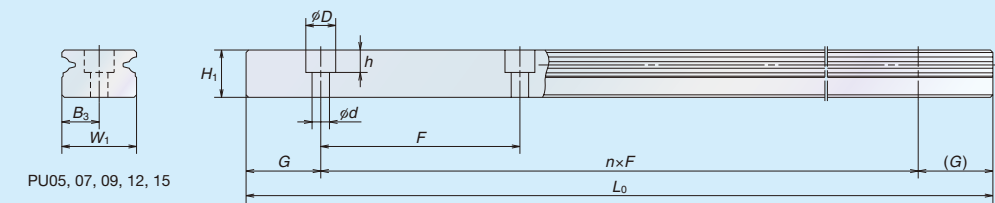

Fig. 11 Rail of interchangeable types (PU series)

Please refer to Table 14 for each part dimension.

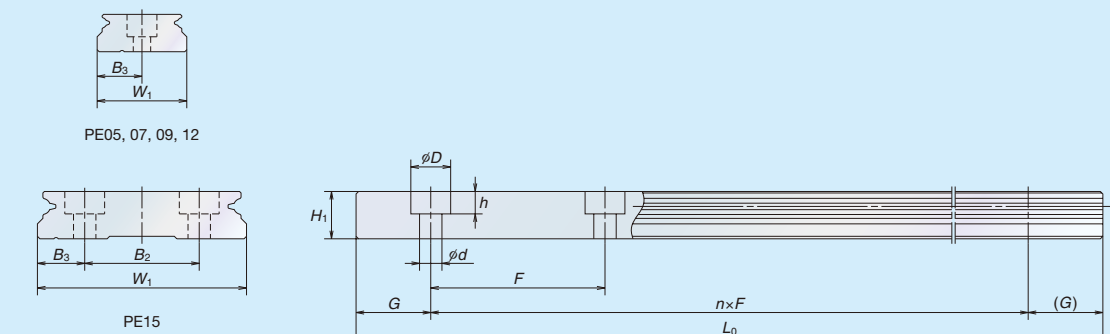

Fig. 12 Rail of interchangeable types (PE series)

10 Interchangeability with LU series/LE series

The PU series/PE series is designed to be interchangeable* with the LU series/LE series for its mounting dimensions and load ratings.

Refer to Figs. 7, 8 and Tables 13, 14 for more details.

(* Load ratings for PU05 and PE05 are not interchangeable.)

11 Handling precautions

- (1) Resin parts such as the end cap may become damaged when struck or hit.
- (2) Maximum operating temperature must be 80°C or below. Exceeding this limit may damage resin parts.
- (3) Maximum operating temperature must be 50°C (max. momentary 80°C) when attaching NSK K1®. Also, avoid exposure to organic solvents with a degreasing effect. Do not immerse in kerosene or rust preventative oil (with kerosene ingredients).
- (4) Handling of interchangeable types
 - ① Interchangeable ball slide will be delivered with a provisional rail (inserting fixture).
 - ② Be sure to use the provisional rail when removing ball slide(s) from a rail.
 - ③ Do not remove the ball slide from provisional rail until inserting into a rail.

Worldwide Sales Offices

NSK LTD.-HEADQUARTERS, TOKYO, JAPAN INDUSTRIAL MACHINERY BEARINGS DIVISION-HEADQUARTERS AFTERMARKET BUSINESS DIVISION-HEADQUARTERS AUTOMOTIVE BUSINESS DIVISION-HEADQUARTERS PRECISION MACHINERY & PARTS DIVISION-HEADQUARTERS	www.nsk.com tel: 03-3779-7227 tel: 03-3779-8893 tel: 03-3779-7189 tel: 03-3779-7163	PT. NSK INDONESIA Jakarta	www.id.nsk.com tel: 021-252-3458	Netherlands: NSK EUROPEAN DISTRIBUTION CENTRE B.V. Tilburg	tel: 013-4647647
Africa South Africa: NSK SOUTH AFRICA (PTY) LTD. Johannesburg	tel: 011-458-3600	Korea: NSK KOREA CO., LTD. Seoul Changwon Plant	www.kr.nsk.com tel: 02-3287-0300 tel: 055-287-6001	Poland: NSK EUROPE LTD. WARSAW LIAISON OFFICE Warsaw	tel: 022-645-1525
Asia and Oceania Australia: NSK AUSTRALIA PTY. LTD. Melbourne	www.au.nsk.com tel: 03-9764-8302	Malaysia: NSK BEARINGS (MALAYSIA) SDN BHD Shah Alam NSK MICRO PRECISION (M) SDN. BHD. Malaysia Plant	www.my.nsk.com tel: 03-7803-8859 www.my.nsk.com tel: 03-8961-3960	NSK BEARINGS POLSKA S.A. Kielce Plant	tel: 041-366-5001
China: NSK HONG KONG LTD. Hong Kong Shenzhen	tel: 2739-9933 tel: 0755-25904886	New Zealand: NSK NEW ZEALAND LTD. Auckland	www.nsk-rhp.co.nz tel: 09-276-4992	NSK EUROPEAN TECHNOLOGY CENTER, POLAND OFFICE Kielce	tel: 041-366-5812
KUNSHAN NSK CO., LTD. Kunshan Plant	tel: 0512-5771-5654	Philippines: NSK REPRESENTATIVE OFFICE Manila	tel: 02-893-9543	NSK STEERING SYSTEMS EUROPE (POLSKA) SP.ZO.O. Walbrzych	tel: 074-664-4101
CHANGSHU NSK NEEDLE BEARING CO., LTD. Jiangsu Plant	tel: 0512-5230-1111	Singapore: NSK INTERNATIONAL (SINGAPORE) PTE LTD. Singapore	tel: 6496-8000	NSK NEEDLE BEARING POLAND SP.ZO.O. Kielce	tel: 041-345-2469
NSK STEERING SYSTEMS DONGGUAN CO., LTD. Dongguan Plant	tel: 0769-2262-0960	Singapore (PRIVATE) LTD. www.nsk-singapore.com.sg Singapore	tel: 6496-8000	Spain: NSK SPAIN S.A. Barcelona	tel: 093-433-5775
ZHANGJIAGANG NSK PRECISION MACHINERY CO., LTD. Zhangjiagang Plant	tel: 0512-5867-6496	Taiwan: TAIWAN NSK PRECISION CO., LTD. Taipei	tel: 02-2509-3305	Turkey: NSK RULMANLARI ORTA DOGU TIC. LTD. STI. Istanbul	tel: 0216-355-0398
SUZHOU NSK BEARINGS CO., LTD. Suzhou Plant	tel: 0512-6665-5666	TAIWAN NSK TECHNOLOGY CO., LTD. Taipei	tel: 02-2509-3305	United Kingdom: NSK BEARINGS EUROPE LTD. Peterlee Plant	tel: 0191-586-6111
NSK CHINA TECHNOLOGY CENTER Jiangsu	tel: 0512-5771-5654	Thailand: NSK BEARINGS (THAILAND) CO., LTD. Bangkok	tel: 02641-2150	NSK EUROPEAN TECHNOLOGY CENTRE Newark	tel: 01636-605-123
NSK (SHANGHAI) TRADING CO., LTD. Shanghai	tel: 021-6235-0198	NSK BEARINGS MANUFACTURING (THAILAND) CO., LTD. Chonburi	tel: 038-454-010	NSK UK Ltd. Newark	tel: 01636-605-123
NSK REPRESENTATIVE OFFICES Beijing	tel: 010-6590-8161	SIAM NSK STEERING SYSTEMS CO., LTD. Chachoengsao	tel: 038-522-343	NSK PRECISION UK LTD. Newark	tel: 01636-605-123
Guangzhou	tel: 020-3786-4833	NSK ASIA PACIFIC TECHNOLOGY CENTER (THAILAND) CO., LTD. Chonburi	tel: 038-454-631	NSK STEERING SYSTEMS EUROPE LTD. Maidenhead	tel: 01628-509-800
Chengdu	tel: 028-8661-4200	Vietnam: NSK VIETNAM CO., LTD. Hanoi	tel: 04-3955-0159	North and South America NSK AMERICAS, INC. (AMERICAN HEADQUARTERS) Ann Arbor	tel: 734-913-7500
NSK (CHINA) INVESTMENT CO., LTD. Shanghai	tel: 021-6235-0198	NSK REPRESENTATIVE OFFICE Ho Chi Minh City	tel: 08-3822-7907	Argentina: NSK ARGENTINA SRL Buenos Aires	tel: 11-4704-5100
Changchun	tel: 0431-8898-8682	Europe NSK EUROPE LTD. (EUROPEAN HEADQUARTERS) Maidenhead	www.eu.nsk.com tel: 01628-509-800	Brazil: NSK BRASIL LTDA. Sao Paulo	www.br.nsk.com tel: 011-3269-4786
NSK CHINA SALES CO., LTD. Shanghai	tel: 021-6235-0198	France: NSK FRANCE S.A.S Paris	tel: 01-30-57-39-39	Canada: NSK CANADA INC. Toronto	www.ca.nsk.com tel: 905-890-0740
NSK-WARNER (SHANGHAI) CO., LTD. Plant	tel: 021-3365-5757	Germany: NSK DEÜTSCHLAND GMBH Düsseldorf	tel: 02102-4810	Mexico: NSK RODAMIENTOS MEXICANA, S.A. DE C.V. Mexico City	www.mx.nsk.com tel: 55-5390-4312
AKS PRECISION BALL (HANGZHOU) CO., LTD. Plant	tel: 0571-2280-1288	NSK PRECISION EUROPE GMBH Düsseldorf	tel: 02102-4810	United States of America: NSK CORPORATION Ann Arbor	www.us.nsk.com tel: 734-913-7500
India: RANE NSK STEERING SYSTEMS LTD. Chennai	tel: 044-274-66002	NEUWEG FERTIGUNG GMBH Munderkingen Plant	tel: 07393-540	NSK AMERICAN TECHNOLOGY CENTER Ann Arbor	tel: 734-913-7500
NSK INDIA SALES CO. PVT. LTD. Chennai	tel: 044-2446-6862	Italy: NSK ITALIA S.P.A. Milano	tel: 0299-5191	NSK PRECISION AMERICA, INC. Franklin	www.npa.nsk.com tel: 317-738-5000
Gurgaon	tel: 0124-4104-530	INDUSTRIA CUSCINETTI S.P.A. Torino Plant	tel: 011-982-4811	NSK STEERING SYSTEMS AMERICA, INC. Bennington	www.nssa.nsk.com tel: 802-442-5448
Kolkata	tel: 033-4001-2062			NSK LATIN AMERICA, INC. Miami	www.la.nsk.com tel: 305-477-0605
Mumbai	tel: 022-2838-7787				

NSK Ltd. has a basic policy not to export any products or technology designated as controlled items by export-related laws. When exporting the products in this brochure, the laws of the exporting country must be observed. Specifications are subject to change without notice and without any obligation on the part of the manufacturer. Every care has been taken to ensure the accuracy of the data contained in this brochure, but no liability can be accepted for any loss or damage suffered through errors or omissions. We will gratefully acknowledge any additions or corrections.

For more information about NSK products, please contact: _____

